

**15 ans d'OMEGA  
+ 35 ans de microélectronique  
= 50 ans d'IN2P3**

Christophe de LA TAILLE  
19 mai 2021





Gargamelle 1970



ALEPH 1990

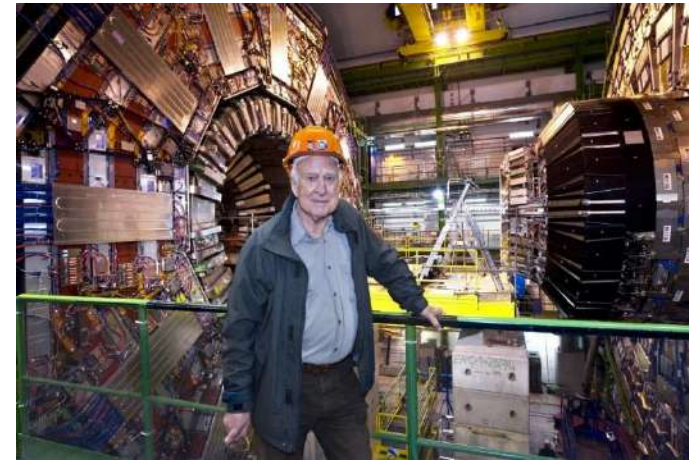

CMS 2010

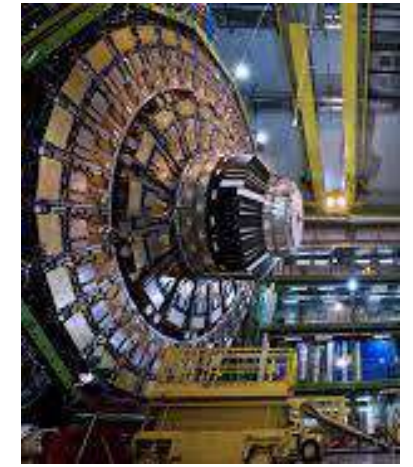

CMS upgrade 2030

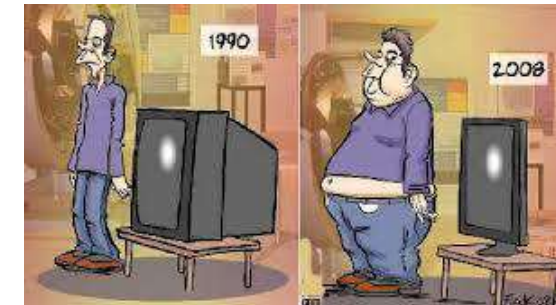



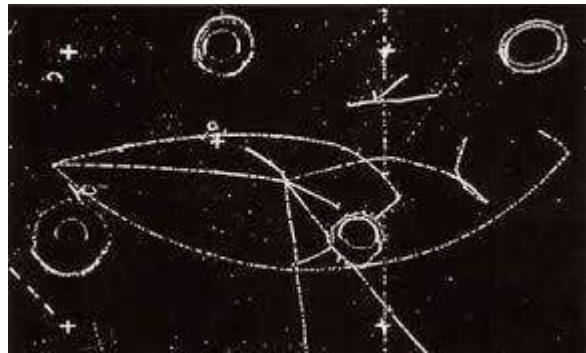

Gargamelle 1970

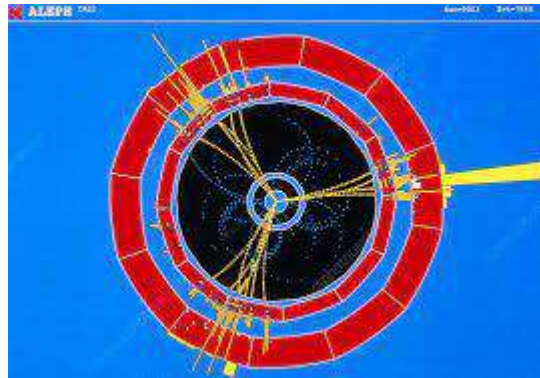

ALEPH 1990

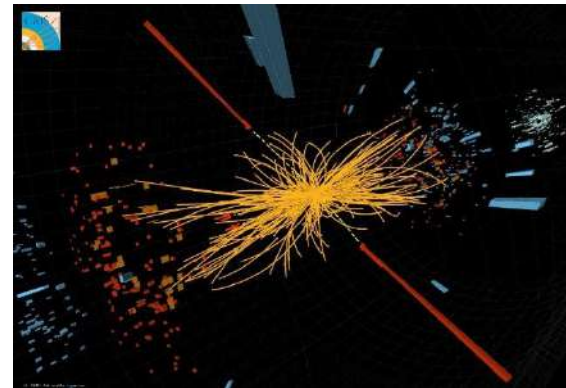

CMS 2010

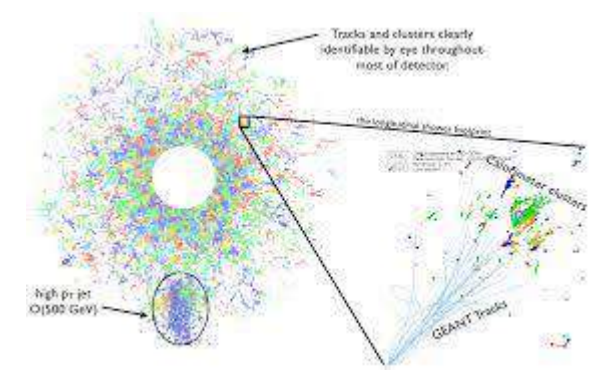

CMS 2030

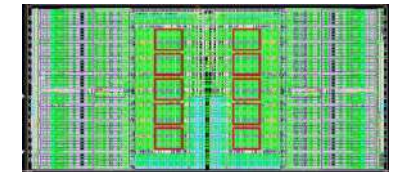
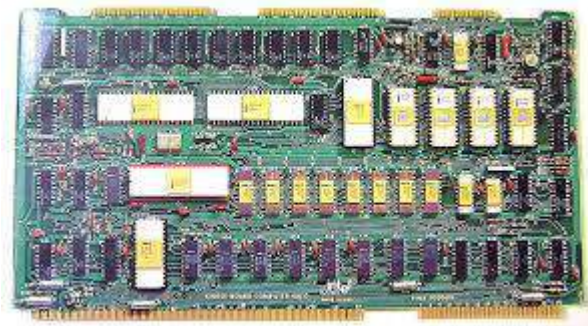



## Microplex 1985

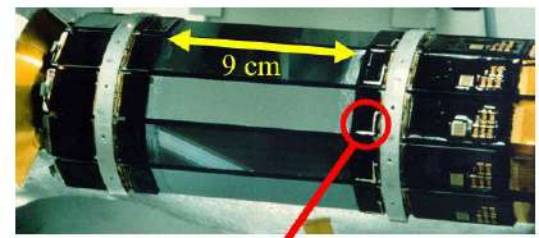

Silicon Strip  
Vertex Detector:  
MARK II experiment  
at SLAC Linear Collider  
(512 channels/module;  
18K channels total)

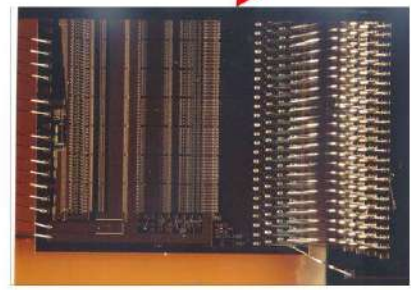

Microplex readout chip  
128 channels, 47.5  $\mu\text{m}$  pitch  
(Walker, Parker, Hyams)

Parallel efforts in ALEPH, DELPHI, OPAL at LEP and CDF at the Tevatron Collider

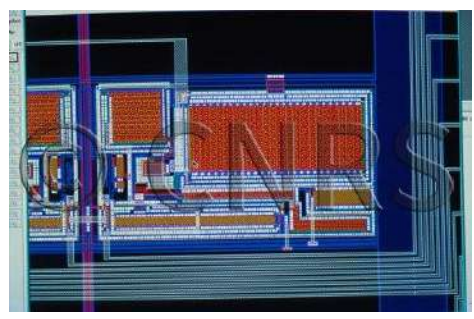

## Timepix4 2020

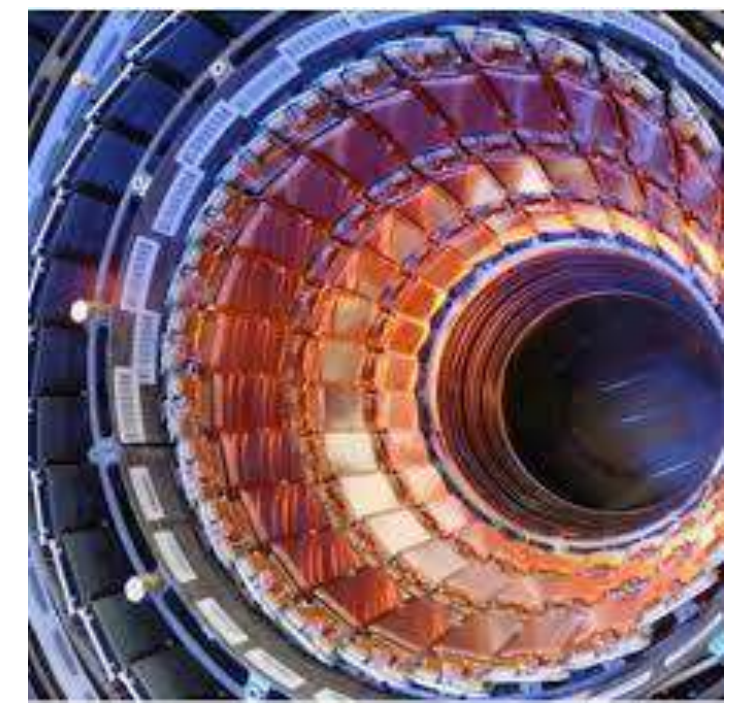

- Analog Front-End:**
  - 13x55  $\mu\text{m}^2$
  - <25% pixel area
- IO Pad on digital area:**
  - Careful shielding
  - Pad is 1/2 of Timepix
- VCO (FTOA):**
  - 9.6x20  $\mu\text{m}^2$
  - < 0.8% SP area
- Super Pixel (SP):**
  - 2x4 pixels
  - 110x220  $\mu\text{m}^2$





# Pourquoi fait-on nos chips au lieu de les acheter ?

- ASIC = Application **Specific** Integrated Circuit
- Innovation et progrès technologique permettent de faire de nouveaux/meilleurs détecteurs
- Contraintes très spécifiques au HEP : interactions physiciens/designers
- Pas de chip => pas de détecteur => pas d'expérience...

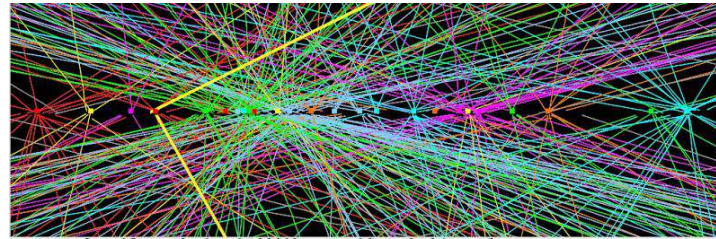

Pixelated 300  $\mu\text{m}$  thick Si detector chip (256 x 256 pixels, 55  $\mu\text{m}$  pitch)

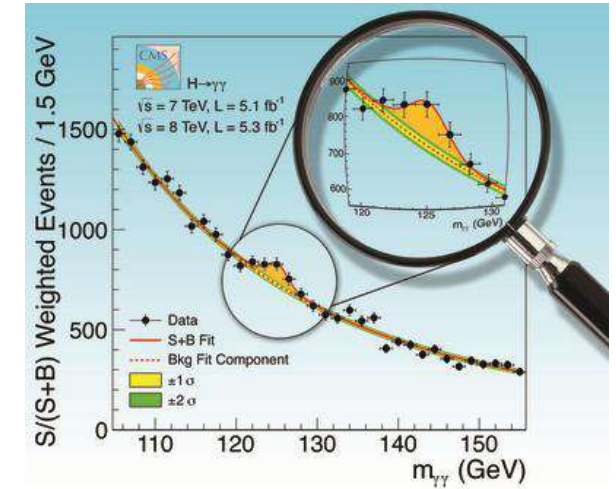
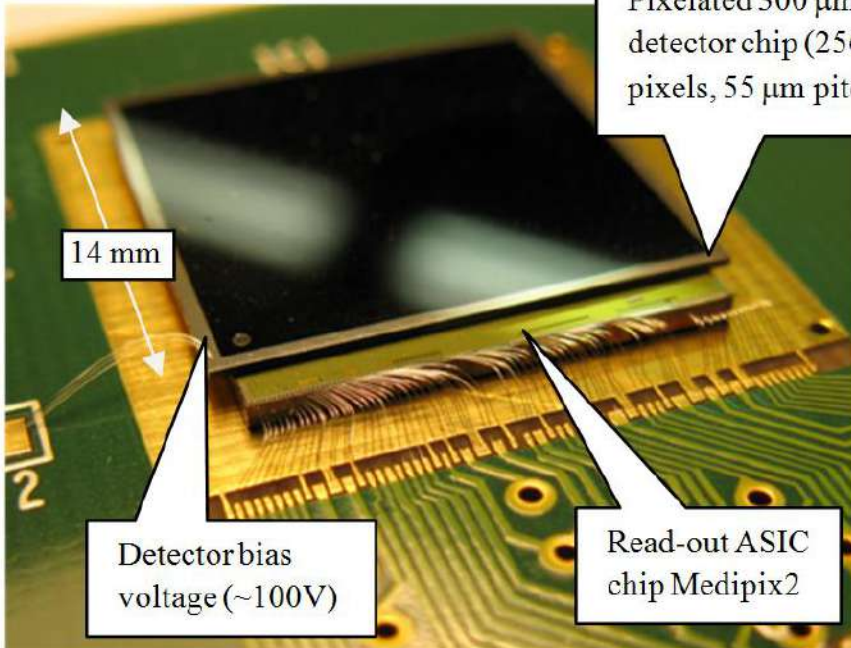

# Pourquoi est-ce si compliqué ?

- La microélectronique permet d'intégrer de plus en plus de fonctions : « System On Chip » (SoC)
- OMEGA :
  - Premier de chip de lecture des PM multi-anodes (OPERA\_ROC 2003)
  - Premier chip de lecture des SiPMs (FLC\_SiPM 2005) !
  - Premier chip de lecture/digitisation calorimètres imageurs (SKIROC2 2010, HGCROC2 2019)
  - Premier chip de lecture/digitisation des diodes de timing picoseconde LGAD (ALTIROC1 2018)

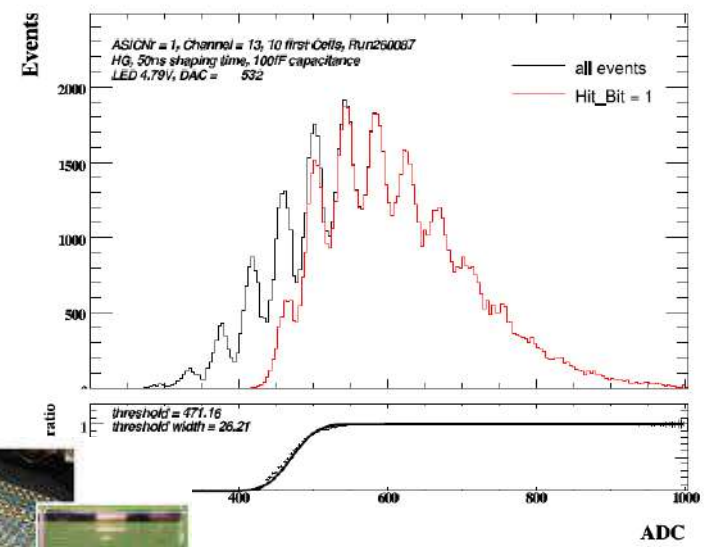
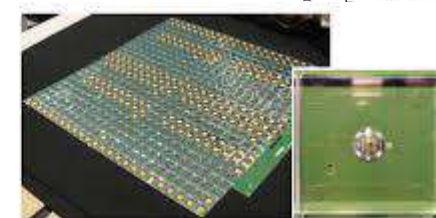
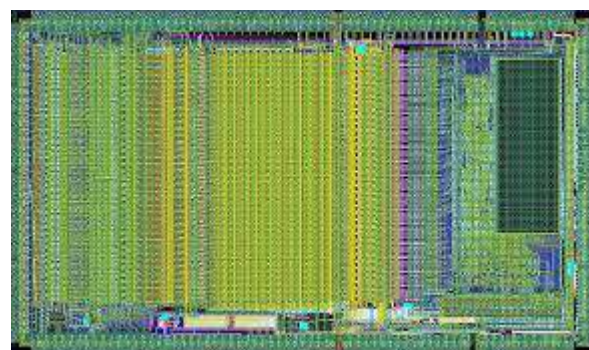
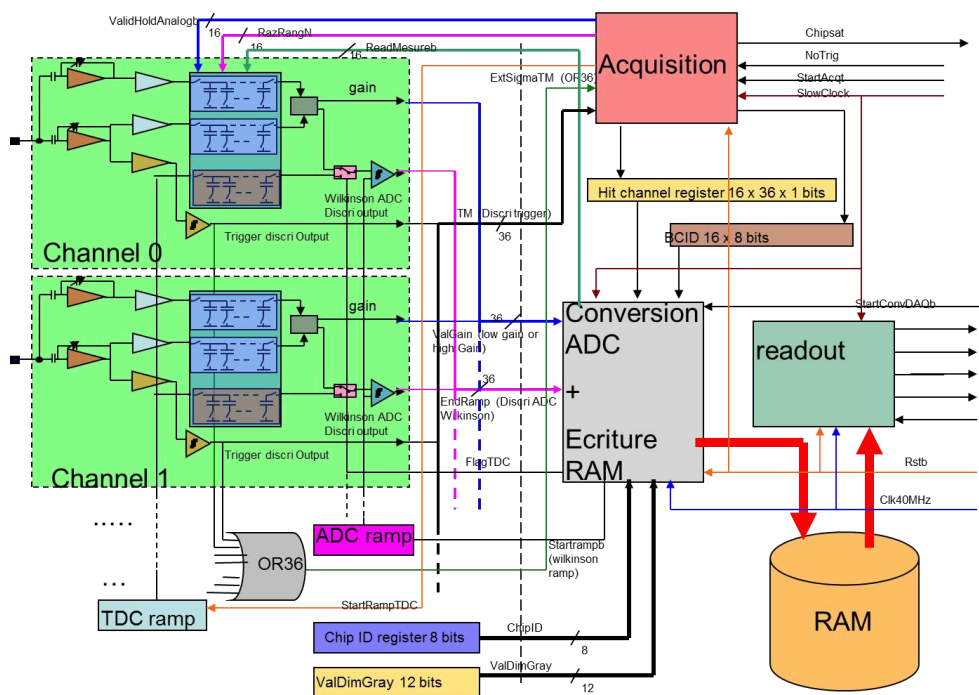
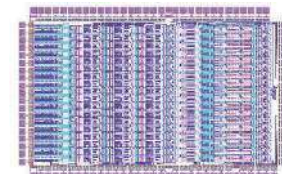



# Evolution des technologies

- Evolution des technologies : de plus en plus complexes et chères

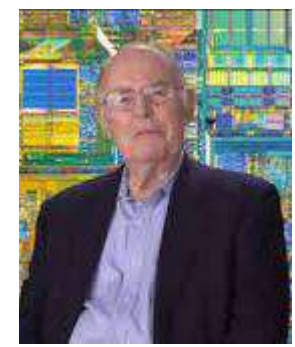
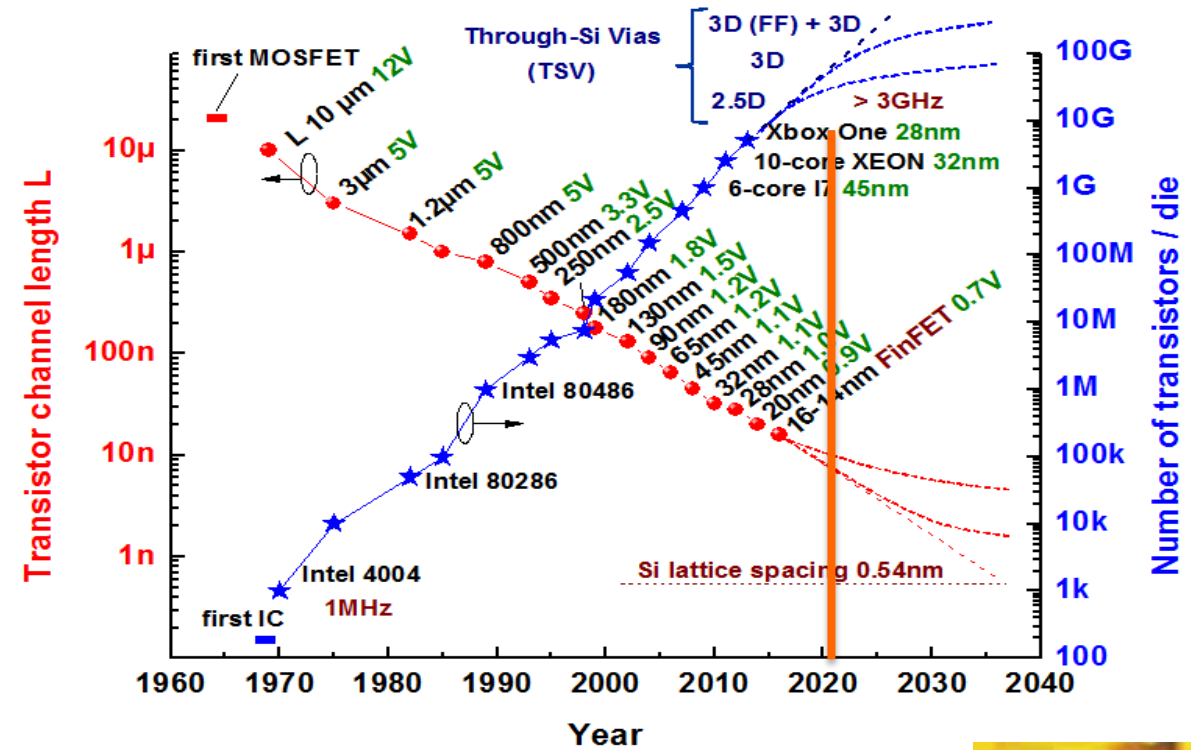

## Géostratégie – Le maître des puces sera celui du monde

ENQUÊTE. La pénurie actuelle de semi-conducteurs exacerbe la guerre technologique. États-Unis, Chine, Taïwan, Europe : état des lieux des forces en présence.

Par Jérémy André (à Hongkong) et Guillaume Grallet



# Pourquoi est-ce un domaine de Recherche ?

- Domaine de recherche : publis/thèses/confs, similaire à détecteurs/accélérateurs/computing
- « L'Art du design » : créativité et innovation
- Nouvelles architectures pour nouveaux détecteurs

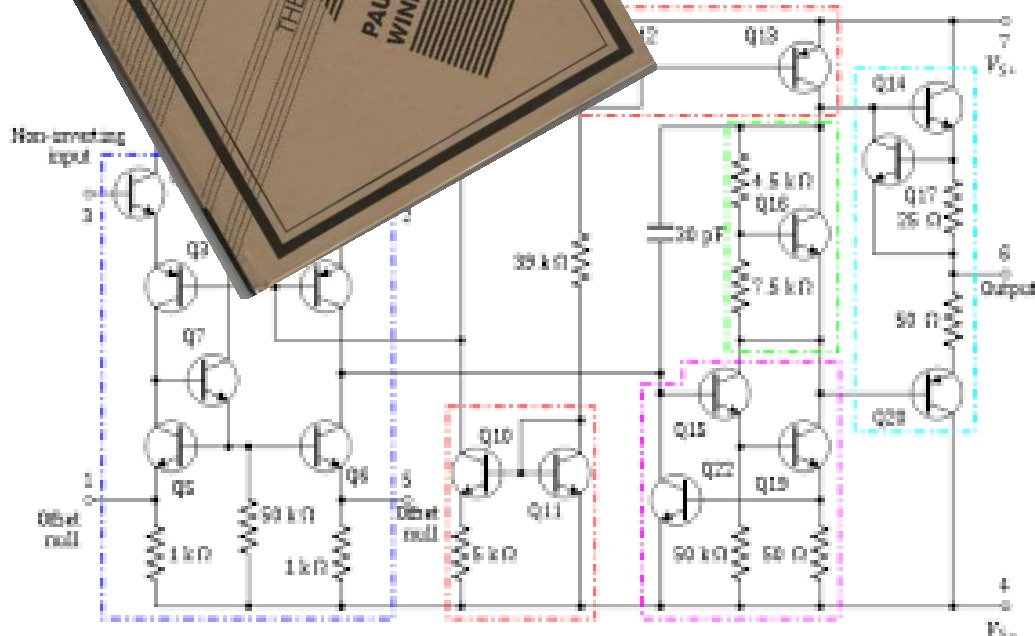
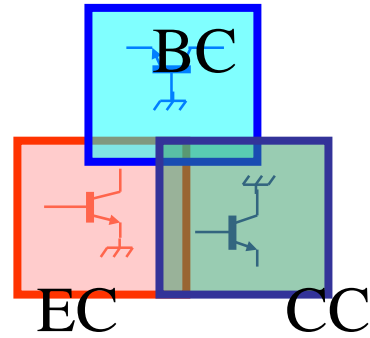
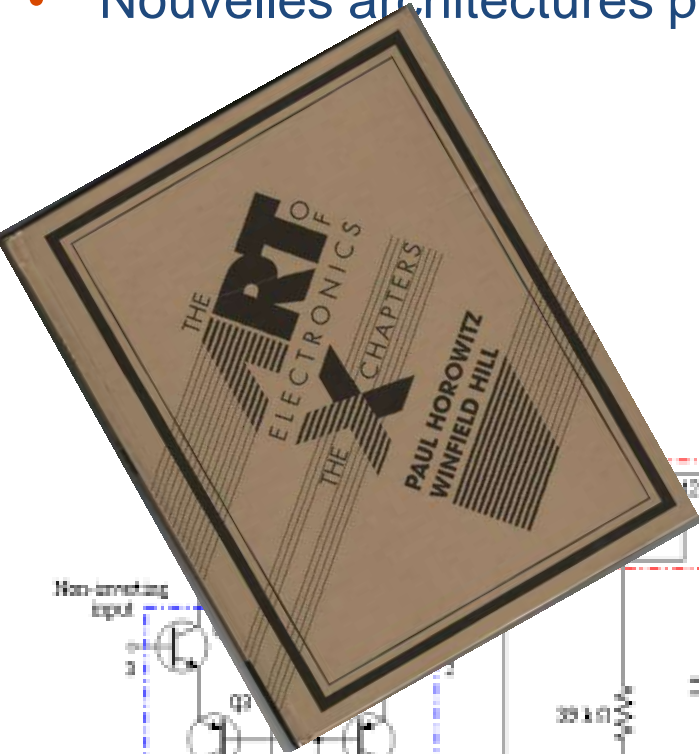



- L'AI pourra-t-elle remplacer les designers ?





- Plateforme nationale pour le conception d'ASICs à destination des détecteurs de **Physique des particules**.
- Créé en 2006 au LAL, devenu UMS à l'X en 2013
- 12 CNRS ingénieurs, hautement spécialisés en conception analogique/numérique bas bruit, résistant aux radiation
- Localisation à l'Ecole Polytechnique pour un lien fort avec l'**enseignement** et les **partenaires industriels** Technology.
- Transfert de technologie avec la startup WEEROC

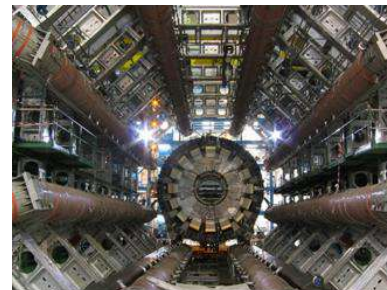
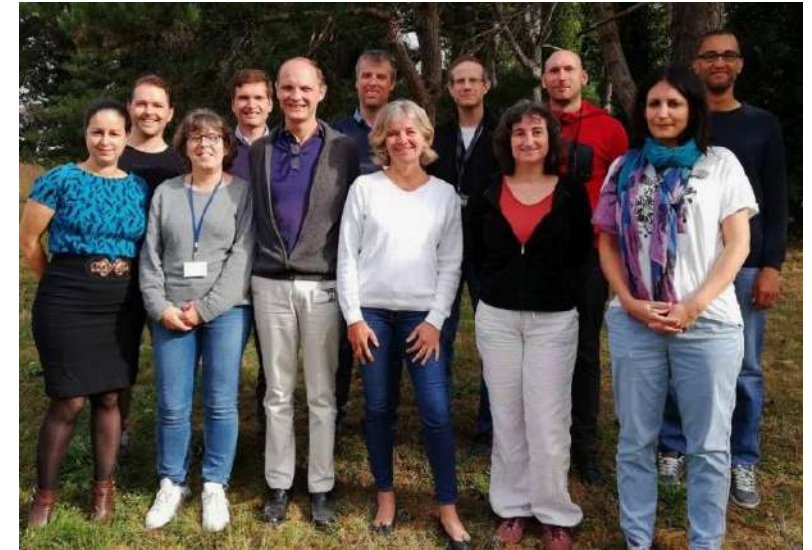

Research,  
Institute



Industry, company



Education,  
School

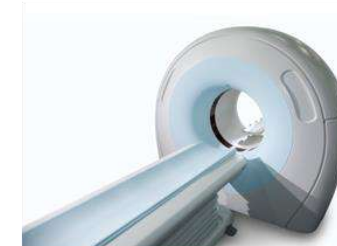



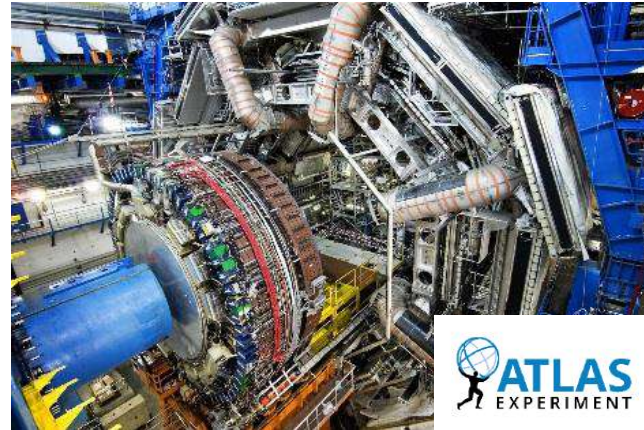

ATLAS EXPERIMENT

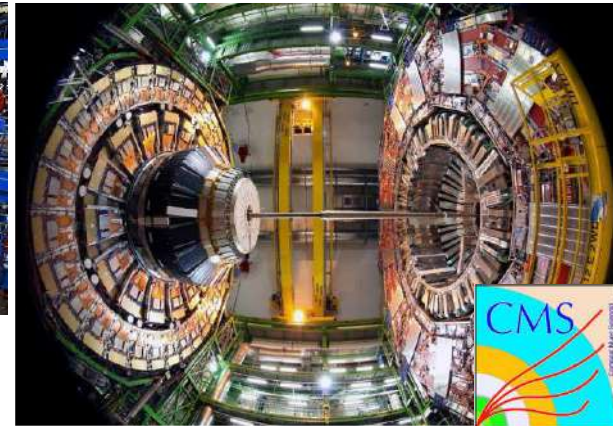

CMS



- Larges productions (engineering runs)
  - $\langle \rangle = 4000$  chips/yr 200 k€
- Responsabilités dans les grandes expériences
  - ATLAS, CMS, EUSO, JUNO
- Excellente visibilité internationale
- Startup : Weeroc
  - Chips dans Ariane !

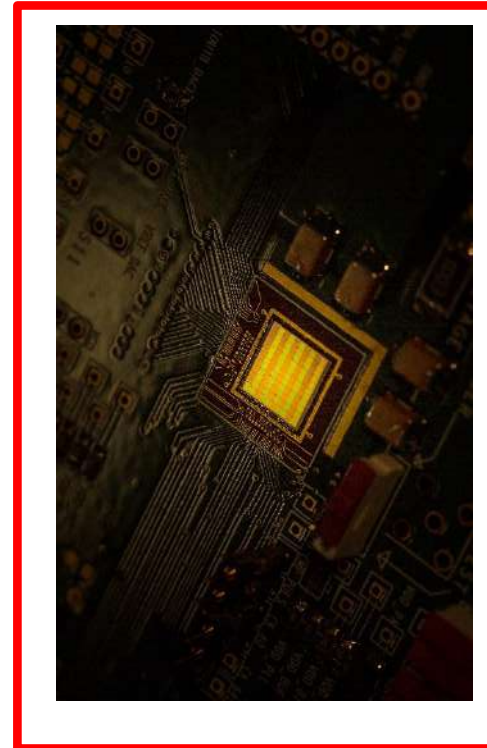



# OMEGA ASICs : produits et installés



MICROROC

MAROC3

2006

PETIROC

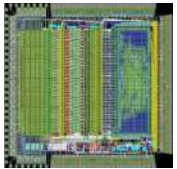

SPACIROC

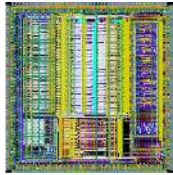

HARDROC

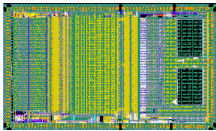

SKIROC

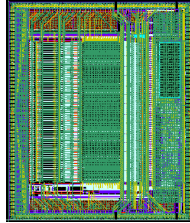

SPIROC

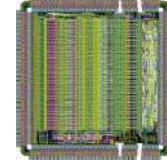
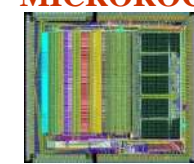
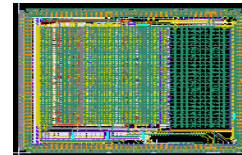

TRIROC



CITIROC

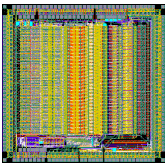

CATIROC

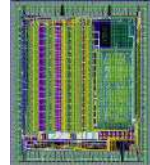

SK2\_CMS

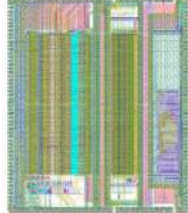

ALTIROC

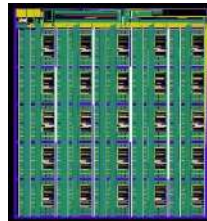

HGROC

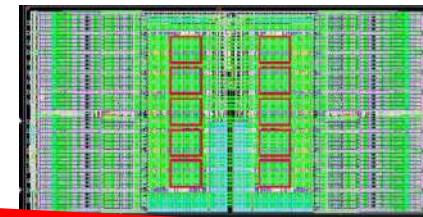

2021

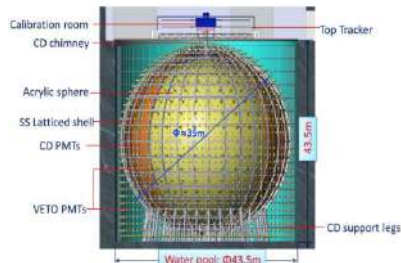
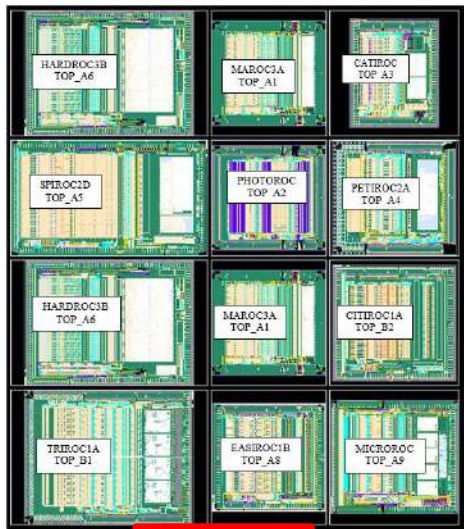
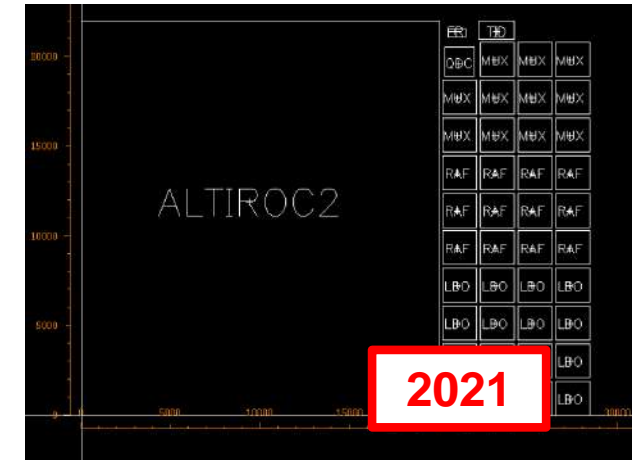

Figure 8.12: Seven 6" silicon sensor modules, equipped with SKIROC-CMS ASIC, mounted on a copper support (existing plane during the 2017 test campaign).





- 6 engineering runs en 8 ans : unique à l'in2p3 !
  - AMS SiGe 0,35um 2014, 2016, 2018
  - TSMc 130nm : 2019, 2020, 2021
  - 6-24 wafers 8" and 12" : des milliers d'ASICs fabriqués et utilisés
  - Coût : 200-300 k€, partagé entre projets : **très efficient !**



2014



2016

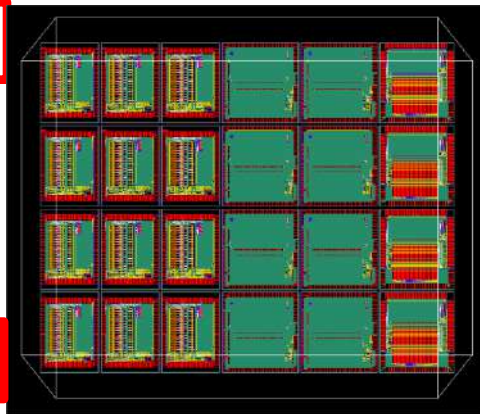

2018

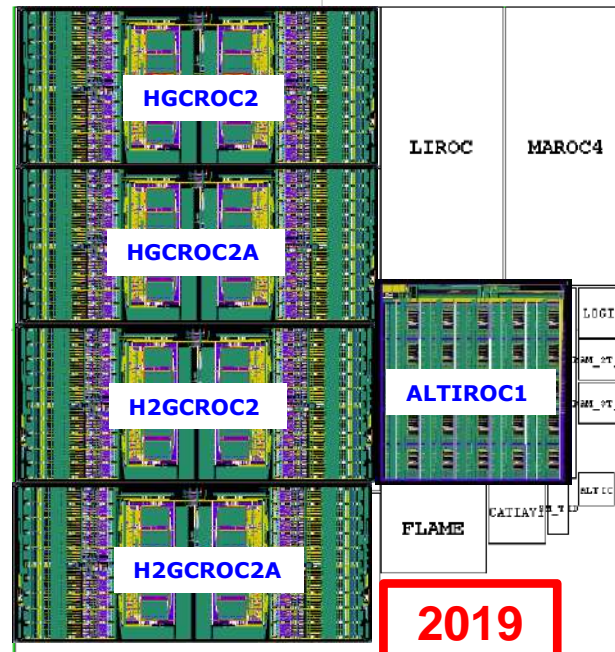

2019

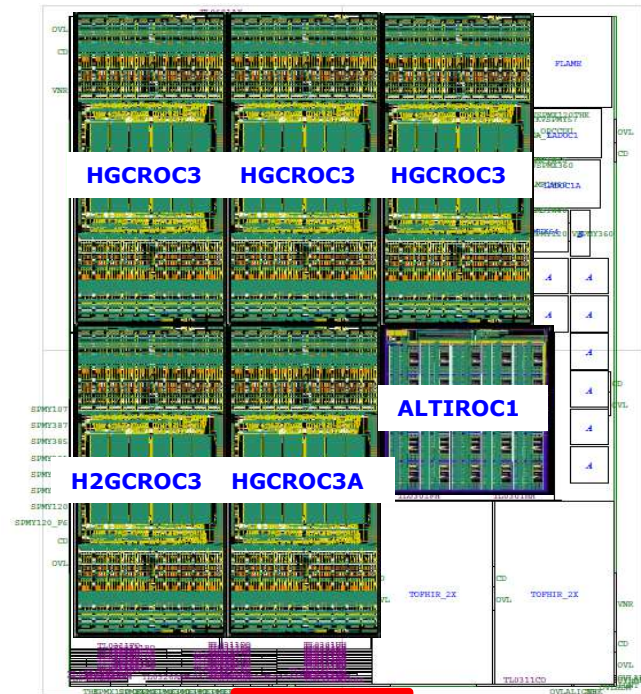

2020



- PET/MRI

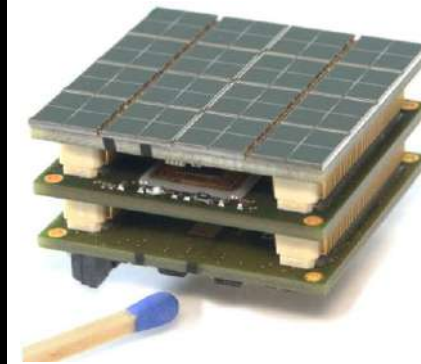
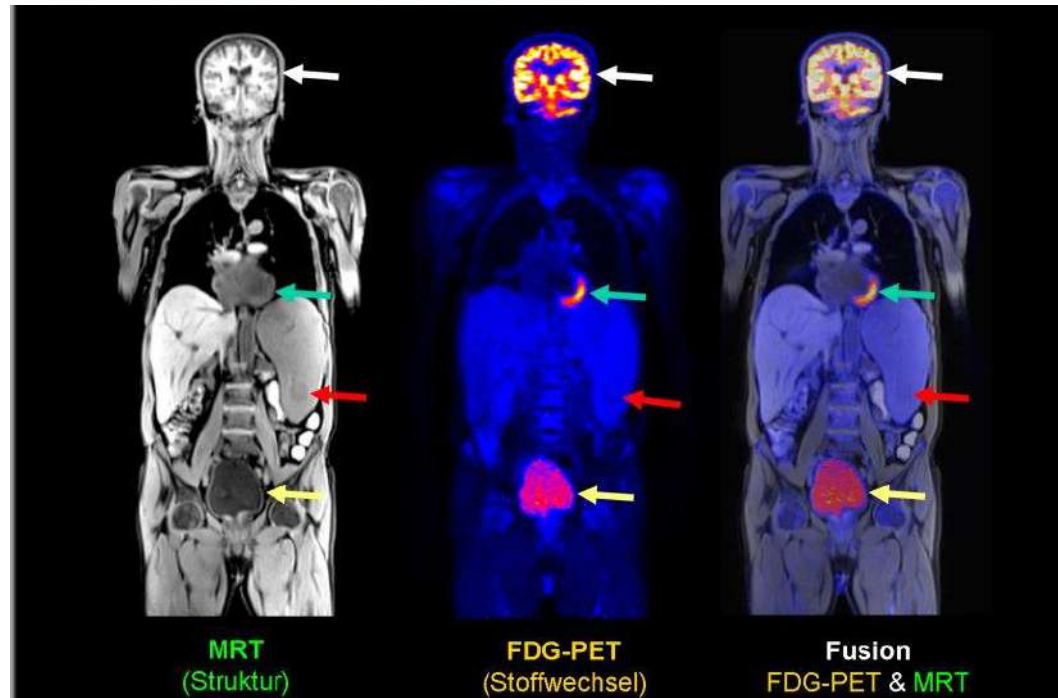
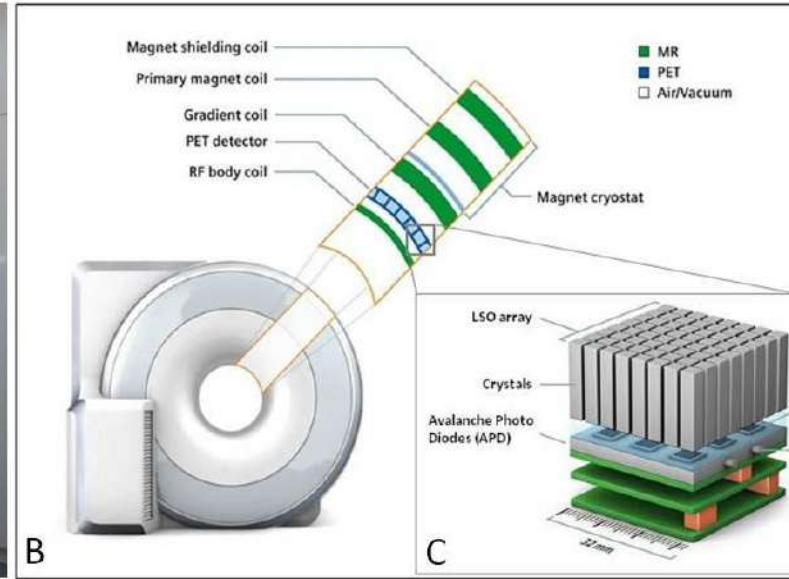



- Startup créée en 2013 pour transfert technologique

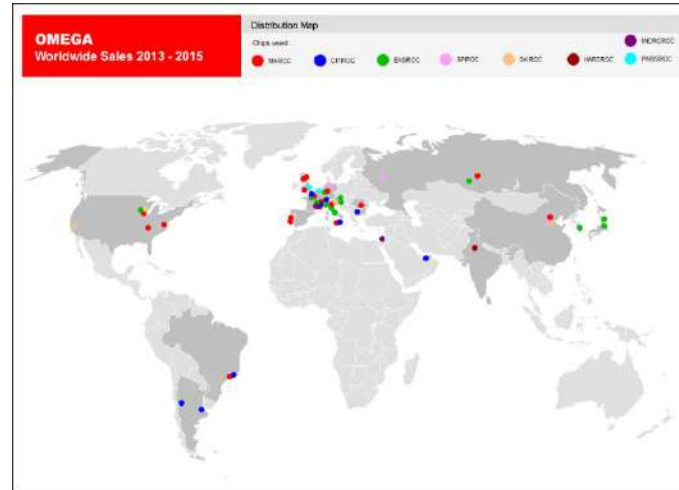

Partenariat CAEN pour distribution ASIC et systèmes



Construction du PET/IRM Trimage



- Utilisation des licences CADENCE industrielles

Premiers évènements Cerenkov – ASTRI  
appel d'offre pour 10 télescopes



partenariat IP spatiaux



Vol des circuits Weeroc sur Ariane 5 et satellites



- CA 2020 : 600 k€
- 7 employés



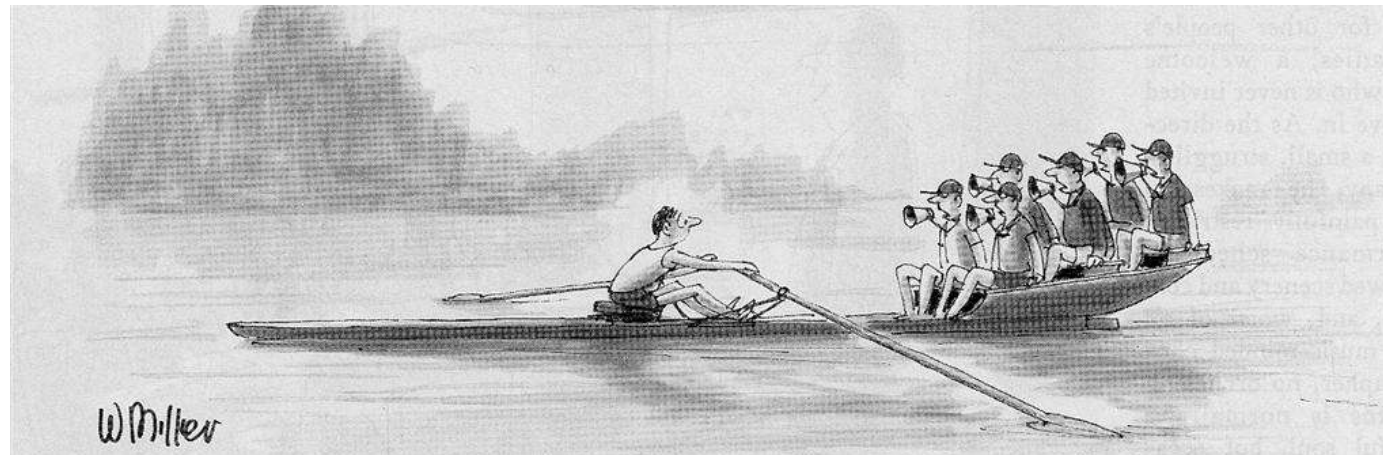



- Les ados n'écoutent pas tellement leurs parents...
- Les parents ne comprennent pas tellement leurs ados...
- Garder ouvert le dialogue !

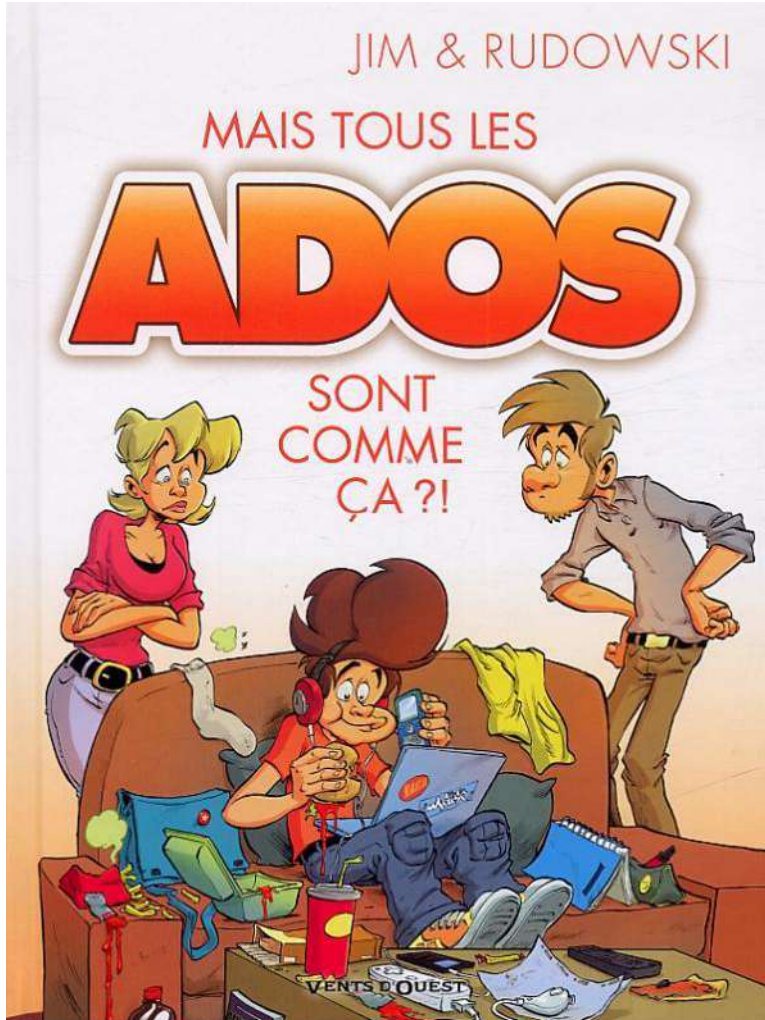

- Concentration dans la « colla-pétition » mondiale
  - Importance de la masse critique et de la visibilité
  - Fort soutien des ASICs à l'international (M\$), moins en France (?)
  - **La structure d'OMEGA a montré son efficacité RH et \$\$**
  - Position privilégiée pour les liens enseignement/industrie
- Pour les grands projets et pour faire face à la complexification croissante : besoin organisation similaire au calcul : TIER0/TIER1/TIER2
  - TIER0=CERN, TIER1=CC/OMEGA, TIER2=labos
  - Le CERN ne voudra/pourra probablement plus interagir avec tous les TIER2
  - L'augmentation des coûts demande une **mutualisation des forces**
  - L'augmentation de la complexité demande une **concentration des expertises**
- Problème d'attractivité en microélectronique dans la recherche publique
- Décalage de compréhension du domaine dans les labos
- La bureaucratie étouffe l'innovation
- La masse critique a augmenté mais pas OMEGA...



**« Derrière l'Institut Pasteur et Sanofi, c'est tout l'appareil de la recherche française qui a décroché »**

[Ph. Escande *Le Monde* 28/1]  
CHRONIQUE





- OMEGA : un laboratoire spécial pour le design d'ASICs !
- Un domaine stratégique pour l'IN2P3 et l'IPP
- 15 ans déjà, le moment de penser à l'avenir...
  
- Encore bon anniversaire à l'in2p3 (et à OMEGA) !
- Et merci à tous celles/ceux qui contribuent à ses succès

